

# BTB MIG Gun Necks & Accessories

Issued March 2021 • Index No. N/1.9

MIG Welding Guns  
Components & Accessories 

<b>Quick Specs</b>	<b>Applications</b> Heavy Equipment Shipbuilding Pipeline Fabrication	<b>Amperage Range</b> 200 - 600 amp	<b>Gun Compatibility</b> BTB MIG Gun Series	<b>System Components</b> Necks, Insulators, Flex Necks
		<b>Neck Angles</b> 0°, 30°, 45°, 60°, 80°	<b>Consumable Compatibility</b> AccuLock™ S, Centerfire™, Quik Tip™, TOUGH LOCK®	<b>Accessories</b> Neck Coupler, Neck Grip

Bernard® BTB MIG guns use aluminum armored necks that **withstand abuse and offer outstanding heat dissipation** for longer life. Available in fixed or rotatable styles in a wide variety of lengths and bends, necks can be selected during gun configuration to **optimize weld puddle access and visibility**. Rotatable necks are interchangeable which allows the gun to be adapted to changing weld access needs for **increased welder comfort and productivity**.

Necks for BTB guns are also **designed to maximize consumables compatibility**. A dual thread on the front of the neck allows installation of your choice of AccuLock™ S, Centerfire™, Quik Tip™ or TOUGH LOCK® consumables. A common neck diameter means that the same consumables can also be used across BTB guns of all amperages.

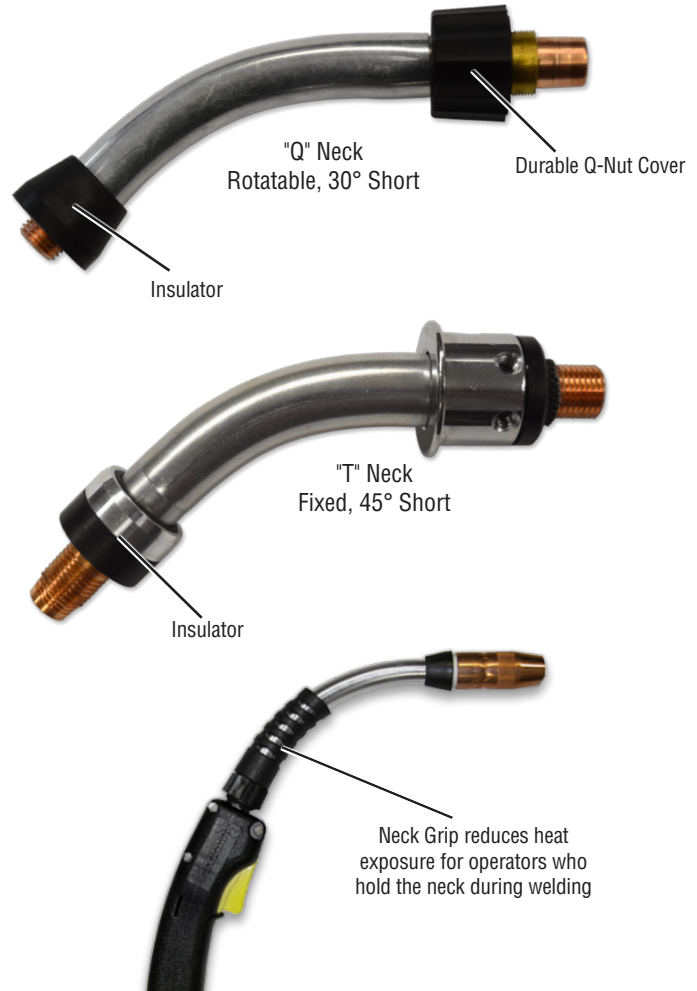

- Compatible with BTB MIG guns and AccuLock S, Centerfire, Quik Tip and TOUGH LOCK consumables
- Wide selection of fixed or rotatable necks
- Available in multiple lengths and bends for limited access welds and improved operator comfort
- Rotatable necks changeover and rotate without tools
- Rotatable necks are easily removable for jump liner changeover



Rotatable necks rotate 360° to access hard to reach welds



Select the best neck style and size to fit your EXACT needs



Select your neck online in the BTB MIG Gun Configurator



**Bernard**  
A Division of Miller Electric Mfg. LLC  
449 West Corning Road  
Beecher, Illinois 60401 USA

Phone: 1-855-MIGWELD (644-9353) (US & Canada Only)  
+1-519-737-3000 (International)  
Fax: 708-946-6726  
For more information, visit us at [Tregaskiss.com](http://Tregaskiss.com)

# Rotatable Necks for B, O, T and C Series Handles

## Fixed Necks for B and O Series Handles

Available through configurator

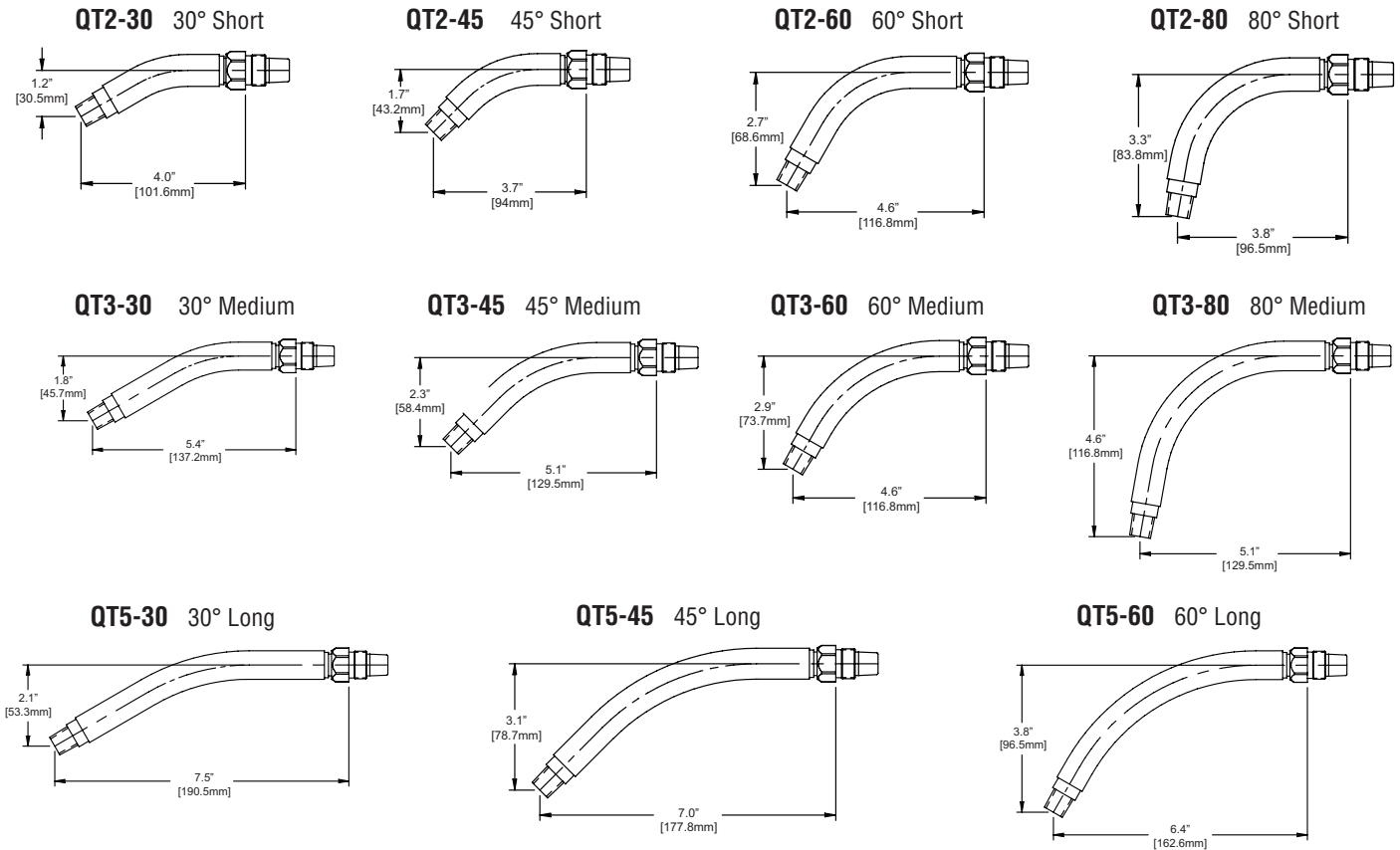

# Fixed Necks on T and C Series Handles

Available through configurator

## T Series Straight Handle

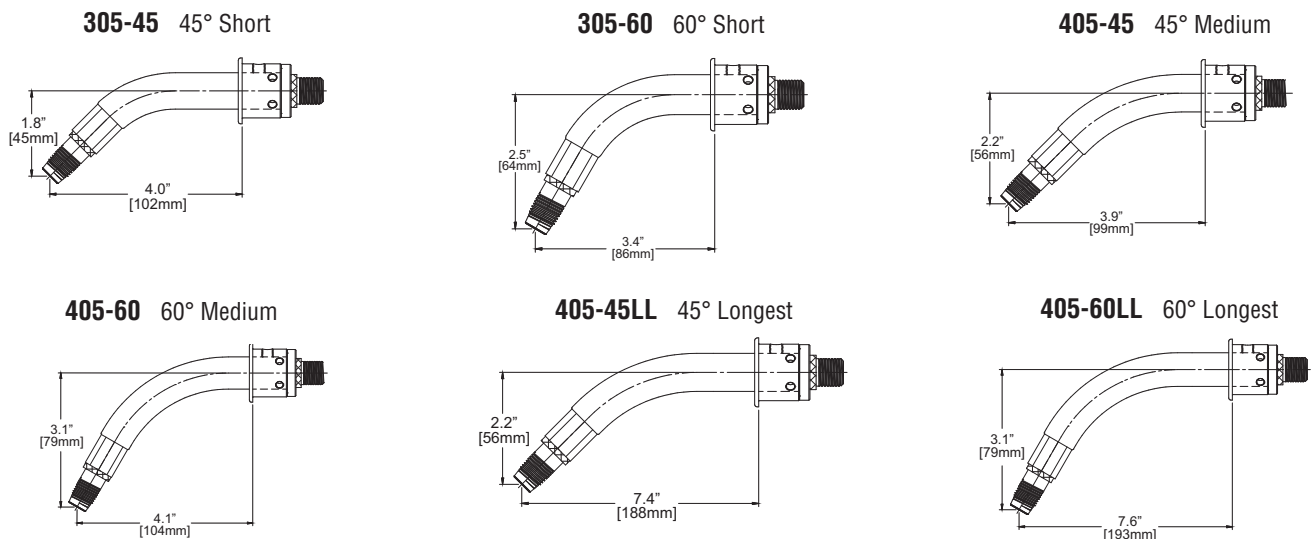

Continued from page 2

**505-45** 45° Long

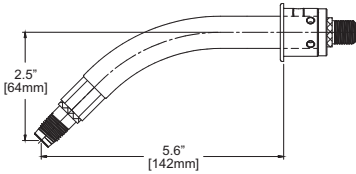

**505-60** 60° Long

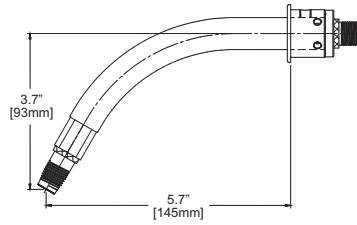

## C Series Straight Handle

**305-45CT** 45° Short

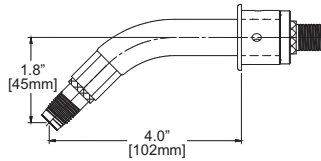

**305-60CT** 60° Short

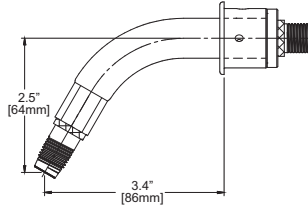

**405-45CT** 45° Medium

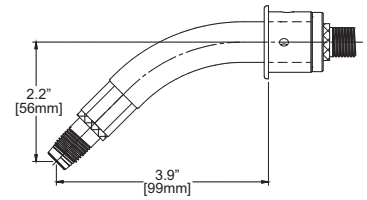

**405-60CT** 60° Medium

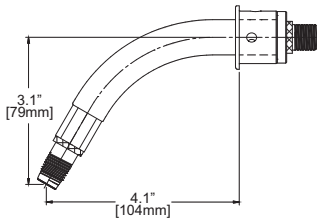

**405-45LLCT** 45° Longest

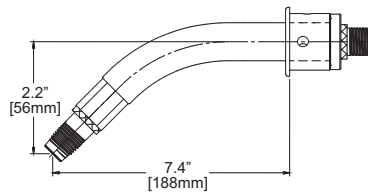

**405-60LLCT** 60° Longest

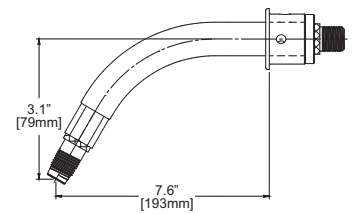

**505-45CT** 45° Long

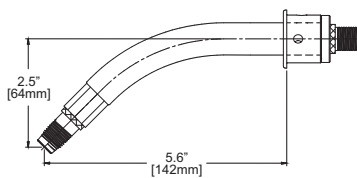

**505-60CT** 60° Long

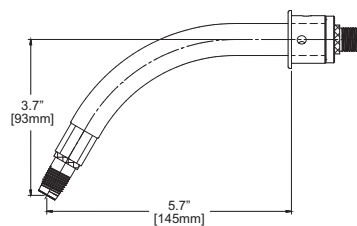

## T Series Small Straight Handle

**205-45** 45° Short

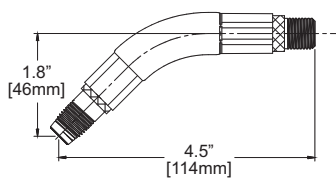

**205-60** 60° Short

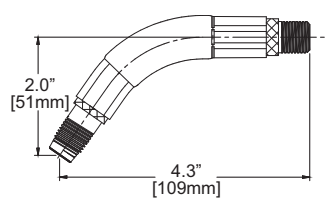

**315-45** 45° Medium

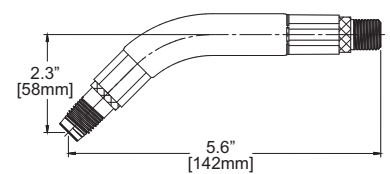

**315-60** 60° Medium

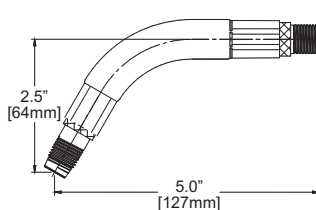

**405-45NB** 45° Long

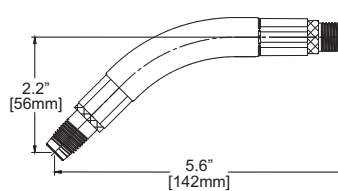

**405-60NB** 60° Long

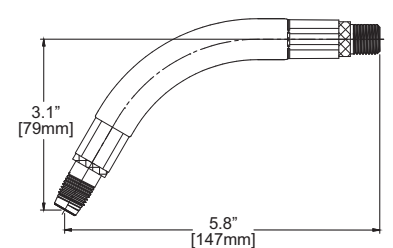

# Neck Insulators

Available as replacement parts

Users should be aware that neck insulator replacement for BTB MIG Guns (Tregaskiss.com/BTB) will be based on several variables including:

- Your gun's amperage;
- Your gun's neck/handle combination;
- The consumable series that you are using.

Please use the following chart when selecting the appropriate replacement neck insulator:

Necks	Handle	Consumables	200A	300A	400A	500A	600A
			Insulator Part Number				
Fixed	T and C Series	AccuLock™ S	402-11				
		Centerfire™	4523R	4423R			
		Quik Tip™	4423R				
		TOUGH LOCK®	402-11				
Rotatable	O, B, T and C Series	AccuLock S	4623R				
		Centerfire	4523R	4423R			
		Quik Tip	4423R				
		TOUGH LOCK	10012				
Fixed	O and B Series	AccuLock S	4623R	402-11			
		Centerfire	4523R	4423R			
		Quik Tip	4423R				
		TOUGH LOCK	10012				

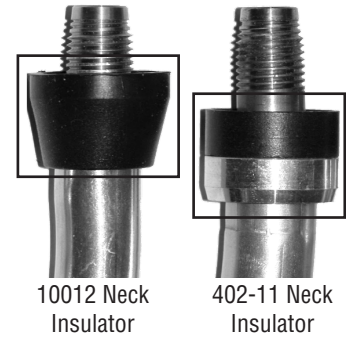

# Q-Nut Cover and Insulators

Available as replacement parts

- 1840031 Silicone Insulator
- 1840057 Q-Nut Cover with insulating ring
- 4780 Nut Insulator

## Q-Nut on Rotatable Neck

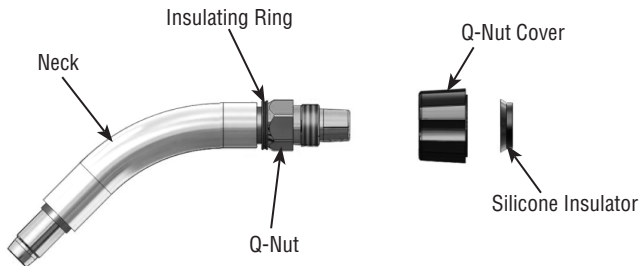

## Nut Insulator on Fixed Neck for B and O Series Handles

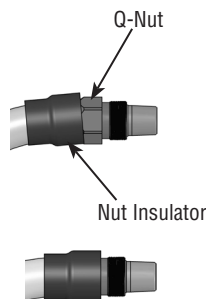

### Q-Nut Cover Installation Instructions for rotatable necks

With gas diffuser/retaining head removed, install insulating ring over the front of the neck and into the space between the aluminum armor and the front face of the Q-Nut.

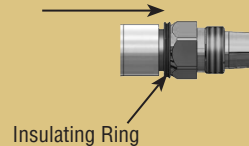

Line up the hex shape on the Q-Nut cover with the hex on the Q-Nut and slide the Q-Nut forward until the part bottoms out. When installed properly, there should be an approximate 1/16" gap between the rear face of the Q-Nut cover and the threads on the Q-Nut.

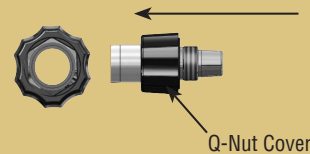

Slide the silicone insulator over the threads of the Q-Nut and press flush up against the rear face of the Q-Nut cover. Ensure that the silicone insulator is orientated in the position shown in the image below.

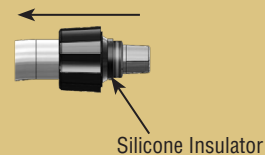

# Neck Replacement Instructions

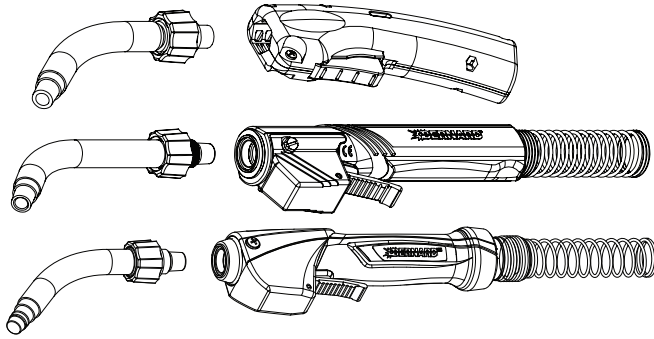

## A. Changing the Neck - Rotatable

1. To remove neck, grasp brass nut and rotate counterclockwise. Rotation will free neck from end fitting. To install the neck, perform the above instructions in reverse order and torque to 38 in-lbs.
2. Liner may need to be changed if switching to a neck of a different bend angle or length.

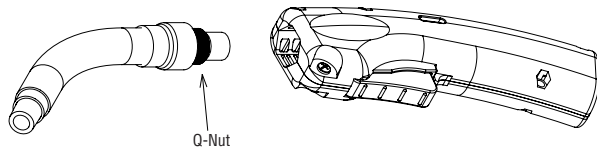

## B. Changing the Neck - Fixed with Curved Handle

1. To remove neck, remove the nut insulator.
2. Using a wrench, rotate brass nut counterclockwise, rotation will free neck from end fitting.
3. To install the neck, perform the above instructions in reverse order and tighten lock nut to 16 ft-lbs (21.7 Nm). Be sure nut insulator is in place.
4. Liner may need to be changed if switching to a neck of a different bend angle or length.

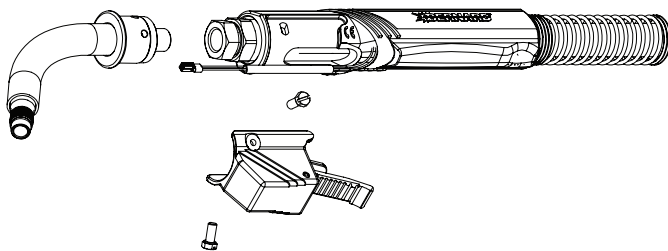

## C. Changing the Neck - Fixed with T Series Straight Handle

1. Place neck in vise. Remove both switch mounting housing screws with an 8 mm nut driver.
2. Slide handle back exposing the cable connection. Loosen the cable/neck connection using a 7/8" wrench.
3. Remove from vise and unthread neck by hand.
4. Thread the neck into the cable connection (hand tighten). Place neck in vise and tighten with a wrench to within 1/8" (3.2 mm) spacing between the cable connection and neck.
5. Install the switch and reposition handle and switch housing.
6. Reinstall switch housing mounting screws.
7. Liner may need to be changed if switching to a neck of a different bend angle or length.

## D. Changing the Neck - Fixed with T Series Small Straight Handle

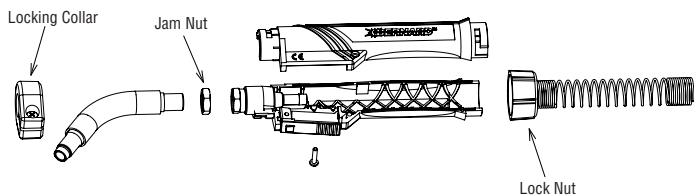

1. Loosen and remove locking collar.
2. Place neck in vise, twist handle lock nut counterclockwise and pull away from handle.
3. Remove screw from handle. Separate handle halves exposing jam nut and front of uncable.
4. Loosen jam nut using two 19 mm wrenches and unthread neck. Remove from vise and unthread neck by hand.
5. Thread jam nut onto new neck. Thread neck into uncable to desired orientation. Place neck in vise, tighten uncable and jam nut.
6. Reposition switch and handle. Reinstall handle lock nut, locking collar and screw.
7. Liner may need to be changed if switching to a neck of a different bend angle or length.

## E. Changing the Neck - Fixed with C Series Straight Handle

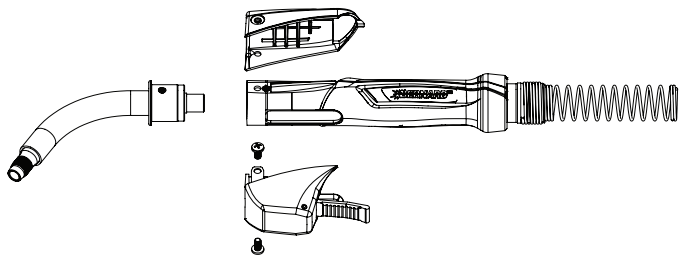

1. Place neck in vise. Remove both switch housing mounting screws with a Phillips screwdriver.
2. Remove both the top and bottom pods from handle.
3. Slide handle back, exposing the cable connection. Loosen the cable/neck connection using a 7/8" wrench.
4. Remove from vise and unthread neck by hand.
5. Thread the new neck into the cable connection (hand tighten). Place neck in vise and tighten with a wrench to within 1/8" (3.2mm) spacing between the cable connection and neck.
6. Install the switch and reposition handle and switch housing.
7. Reinstall switch housing mounting screws.
8. Liner may need to be changed if switching to a neck of a different bend angle or length.

## Accessories

*Not configurable, please order separately*

### Neck Grips



#### For Curved Handle MIG Guns

This high temperature rubber sleeve for curved handle MIG guns provides the operator with improved accuracy and reduced heat exposure. The neck grip is designed to help users hold the neck in a steady position, improve overall weld quality and reduce operator fatigue.

**1840067**



#### For T Series Handles

This neck grip features a heavy duty metal spring for straight handle MIG guns configured with fixed necks. Designed to reduce heat exposure and help users hold the neck in a steady position in order to improve weld quality and reduce operator fatigue.

**406-1 use with 405-60 Neck**

**406-2 use with 405-45 Neck**

**206-1 use with 305-60 Neck**

**506-1 use with 505-45 Neck**

### Q-Neck Coupler



The Q-Neck coupler is designed to connect any two Q-Necks for flexibility and to minimize the need for special-order necks. Compatible with any rotatable necks.

**QT-CPL**

# Additional Options

*Not configurable, please order separately*

## Flex Necks



### For B Series and O Series Handles

Save labor and time — change, rotate or bend the flex neck to your desired angle without tools. Available in 6" and 8" lengths and is easily removable for jump liner changeover. Compatible with Bernard® Centerfire™ and Quik Tip™ consumables.

- QT-F-6      6" length
- QT-F-8      8" length



### T Series Handles

The flex neck for T Series handles features a braided copper conductor tube with a bend radius of up to 80° allowing you to reach your weld joints comfortably. The flex neck can be replaced without disturbing cable connections and is compatible with select Tregaskiss® TOUGH LOCK® and TOUGH ACCESS™ consumables.

**405-FL**

*See Flex Neck Spec Sheet (SP-FN) for more information*

## Rotatable Neck Adaptor for Straight Handle Fixed Necks

The 1680085 and 1680085C adaptor is used to convert straight handle BTB MIG guns from fixed to rotatable necks. Compatible with T Series straight handles and C Series straight handles only.



**1680085** Rotatable Neck Adaptor  
*(required for use with T Series handles only)*



**1680085C** Rotatable Neck Adaptor  
*(required for use with C Series handles only)*

## Specialty Necks

*Not configurable, please order separately*

There are additional standard necks available for order separately in multiple lengths and bends that will help ensure a high quality weld and to improve operator comfort.

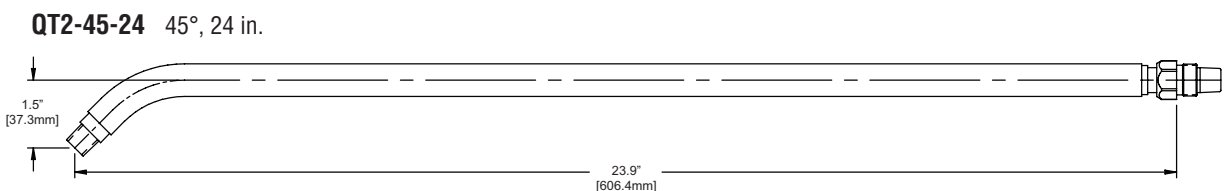
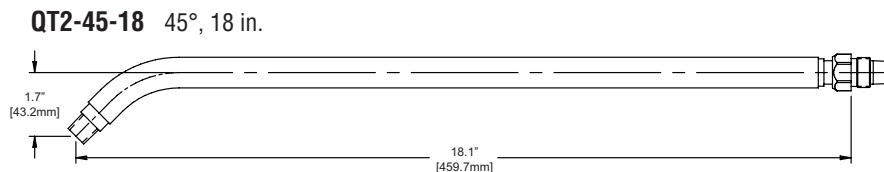
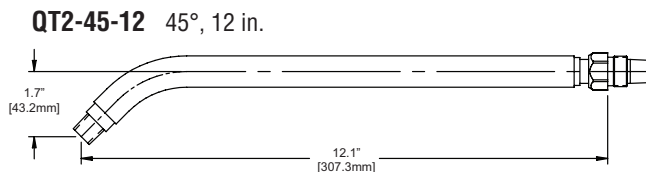

Continued from page 7

**QT-180-3** 0°, 3 in.

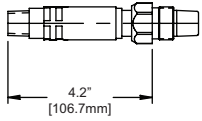

**QT-180-5** 0°, 5 in.

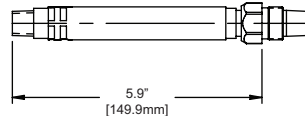

**QT-180-7** 0°, 7 in.

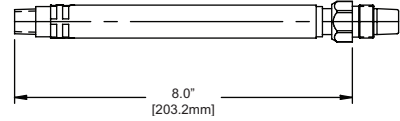

**QT-180-12** 0°, 12 in.

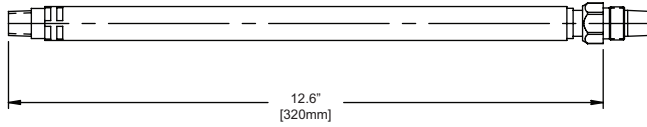

**QT-180-18** 0°, 18 in.

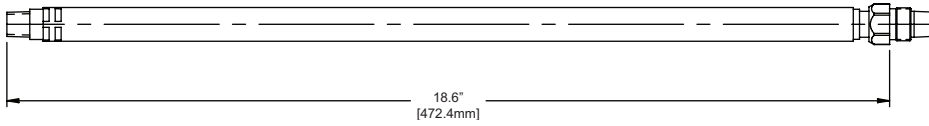

**QT-180-24** 0°, 24 in.

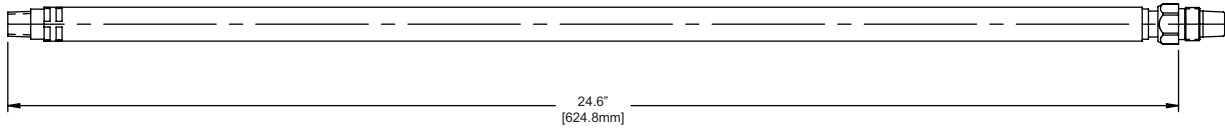

Subject to Change – The information presented in this spec sheet is accurate to the best of our knowledge at the time of printing.  
Please visit [Tregaskiss.com](http://Tregaskiss.com) for the most up-to-date information.

**Distributed By:**