

Available Necks

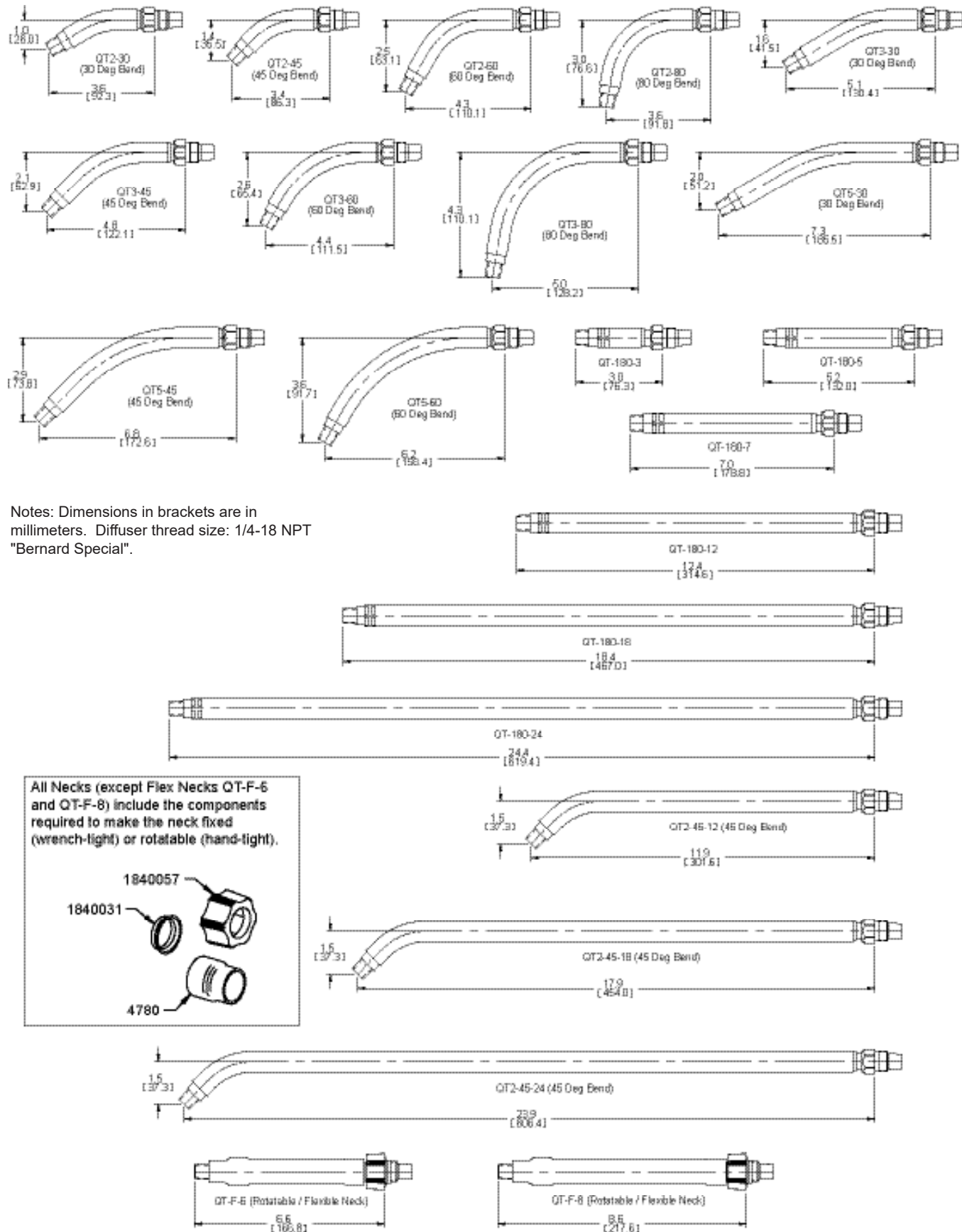

Spool Gun & Push-Pull Gun Conversion Kits

MIG Welding Accessory

Issued July 2013 • Index No. SPEC SGA-1.4

The Right Tool For The Job.

To improve comfort and minimize downtime, these conversion kits enable the use of long-lasting Centerfire™ Consumables and a wide variety of interchangeable necks for greater flexibility and better weld puddle visibility.

Centerfire™ Contact Tips, Nozzles and Diffusers are easy-to-use and high performing - they provide better arc starts, less spatter and more consistent welds - and also last up to three times longer than competitive brands.

Centerfire™ Consumables fit most competitive brand guns to enhance performance and allow standardization of one contact tip and nozzle for all gun brands to minimize inventory management costs.

Necks available in fixed, rotatable, flexible and multiple length options for optimal weld accessibility and improved operator comfort. Rotatable necks changeover without tools.

Large tapered Stay-Tite™ Technology neck connection improves conductivity for better weld quality, lessens heat to increase operator comfort.

Jump Liner allows quick neck change and replacement of only most commonly worn or clogged liner area, which reduces the amount of time a gun is offline and minimizes inventory.

SGA-1 Conversion Kit



Spool Gun & Push-Pull Conversion Kits allow the use of innovative Bernard front-end parts for improved performance and productivity.

CALIFORNIA PROPOSITION 65 WARNING

This product contains chemicals, including lead, known to the state of California to cause cancer, and birth defects or other reproductive harm. Wash hands after use.



Available Parts

| SGA-1: Fits Miller® Spoolmatic 15A, Spoolmatic 30A and XR-A | | |
|---|----------|--|
| ITEM # | PART # | DESCRIPTION |
| 1 | 4929 | O-Ring (2 Required) |
| 2 | 1910042 | .035" - 3/64" (.9 mm - 1.2 mm) Aluminum Jump Liner, SGA Kit |
| 3 | 1910043 | 3/64" - 1/16" (1.2 mm - 1.6 mm) Aluminum Jump Liner, SGA Kit |
| 4 | 1010026A | Adapter with O-Rings |
| SGA-2: Fits Profax® AEC 200 | | |
| ITEM # | PART # | DESCRIPTION |
| 1 | 1910042 | .035" - 3/64" (.9 mm - 1.2 mm) Aluminum Jump Liner, SGA Kit |
| 2 | 1910043 | 3/64" - 1/16" (1.2 mm - 1.6 mm) Aluminum Jump Liner, SGA Kit |
| SGA-3: Fits Miller® XR-Aluma-Pro | | |
| ITEM # | PART # | DESCRIPTION |
| 1 | 2040019 | O-Ring (2 Required) |
| 2 | 2030031 | Retaining Nut, XR-Aluma-Pro |
| 3 | 1910042 | .035" - 3/64" (.9 mm - 1.2 mm) Aluminum Jump Liner, SGA Kit |
| 4 | 1910043 | 3/64" - 1/16" (1.2 mm - 1.6 mm) Aluminum Jump Liner, SGA Kit |
| 5 | 1010033 | Adapter Without O-Rings |
| SGA-4: Fits Fronius® Push-Pull Gun | | |
| ITEM # | PART # | DESCRIPTION |
| 1 | 1010035 | Adapter |
| 2 | 1010034 | Adapter Guide Button |
| 3 | 1920271 | .035" - .3/64" (.9 mm - 1.2 mm) Aluminum Jump Liner, SGA Kit |
| SGA-5: Fits Miller® XR-Pistol-Pro | | |
| ITEM # | PART # | DESCRIPTION |
| 1 | 2040019 | O-Ring (2 Required) |
| 2 | 2030031 | Retaining Nut, Aluma Pro |
| 3 | 1910044 | 0.035-3/64 (.9mm-1.2mm) Aluminum Jump Liner, SGA Kit |
| 4 | 1910045 | 3/64-1/16 (1.2mm-1.6mm) Aluminum Jump Liner, SGA Kit |
| 5 | 1010033 | Adapter Without O-Rings |

SGA-1, SGA-2, SGA-3, SGA-4, and SGA-5 conversion kits are manufactured by Bernard™. Bernard™ is a trademark of Illinois Tool Works, Inc. Miller® is a registered trademark of Miller Electric Mfg. Co., a division of Illinois Tool Works Inc.

Other brands mentioned are for reference only and are the registered trademarks of their respective companies. Illinois Tool Works, Inc. is not affiliated with these other companies.

Available Parts Continued

SGA-1: Fits Miller® Spoolmatic 15A, Spoolmatic 30A and XR-A

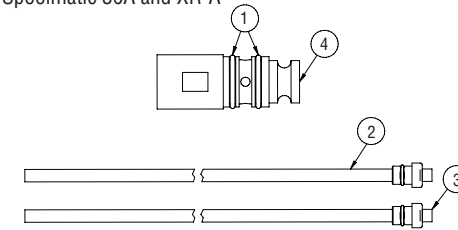

SGA-2: Fits Profax® AEC 200

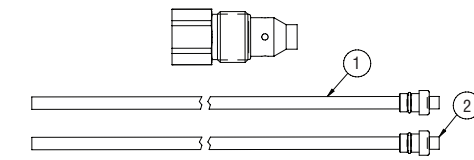

SGA-4: Fits Fronius® Push-Pull Gun*

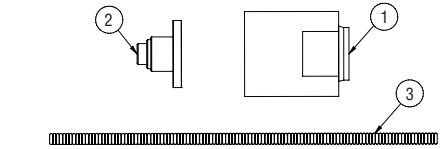

SGA-3: Fits Miller® XR-Aluma-Pro

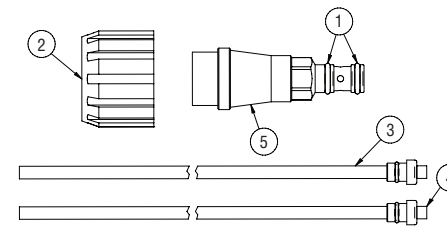

SGA-5: Fits Miller® XR-Pistol-Pro

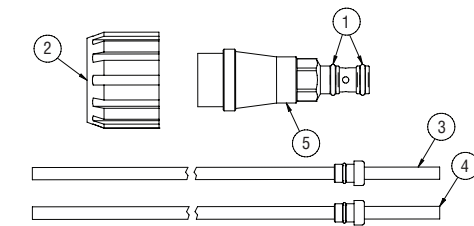

Installation Instructions

1. Remove existing barrel assembly per gun manufacturer's directions
2. Install plastic liner from kit into neck/adaptor assembly as shown below.
 - 2a. (Optional) Trim plastic liner flush with end of adapter to use standard Bernard Jump Liner in neck. See Jump Liner spec sheet for additional options.
3. Connect Bernard Neck to brass adapter. See back page for available neck options.
4. Install neck/adaptor assembly into gun. Secure per gun manufacturer's directions.
5. Trim liner beyond neck threads as appropriate for gas diffuser used (3/4" for Centerfire).
6. Attach Bernard Centerfire™ Consumables to neck. See Centerfire spec sheet for available options.

All SGA Kits*

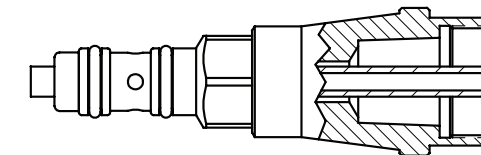

When using optional Jump Liner in neck, trim the plastic liner from SGA Kit flush with the front edge of the brass adapter as shown.

SGA-2 Kit Only

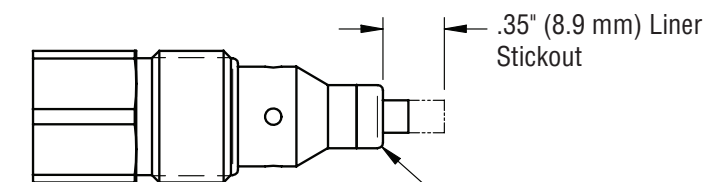

Adjust liner stickout dimension by threading brass liner lock deeper onto plastic material. Turn clockwise for approximately 8 turns.

*Installation Instructions for the SGA-4 kit can be obtained by calling Bernard Customer Service at 1-800-946-2281 or visit BernardWelds.com